

ELECTRICAL OPTIONS/ SPECIFICATIONS

OUTPUT	SUPPLY (NOM.)		
'A' 0.5 - 4.5V RATIO METRIC	5V		
SUPPLY CURRENT 12mA TYP. 20mA MAX.			
CONNECTIONS;	CABLE 3-CORE	CABLE 5-CORE	CONNECTOR
+Ve	RED	RED	:1
+ SENSE (5-WIRE ONLY)	-	ORANGE	:1
0V	BLACK	BLACK	:3
- SENSE (5-WIRE ONLY)	-	GREY	:3
OUTPUT	WHITE	WHITE	:2
BODY	SCREEN	SCREEN	:4

CABLE; 0.2mm², O/A SCREEN, PUR JACKET, SUPPLIED WITH 50cm OR REQUIRED LENGTH IN cm (1500cm MAX).
 STANDARD 3-CORE: BLACK Ø4mm JACKET e.g. L50
 OPTIONAL 5-CORE: BLUE Ø4.6mm JACKET e.g. LQ50
 CONNECTORS; MAXIMUM CONDUCTOR CROSS SECTION 0.25mm²

RANGE OF DISPLACEMENT FROM 0-2mm TO 0-50mm IN INCREMENTS OF 1mm e.g.36.
 BODY MATERIAL:- STAINLESS STEEL.

SPRING LOADED PLUNGER WILL RETRACT FLUSH WITH NOSE AND EXTEND A FURTHER 2mm BEYOND THE END OF CALIBRATED TRAVEL

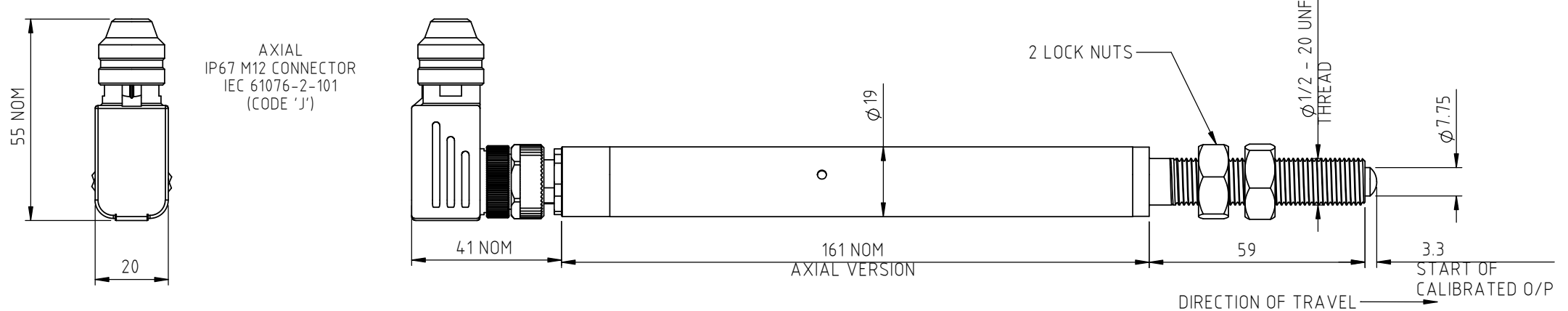
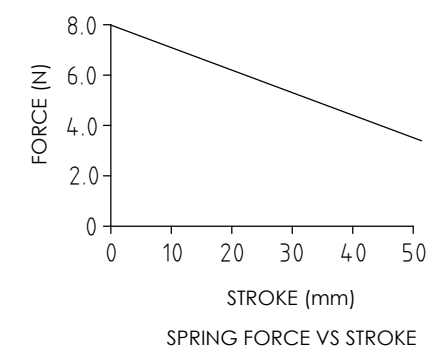

AXIAL
IP67 M12 CONNECTOR
IEC 61076-2-101
(CODE 'J')

AXIAL
IP67 Pg9 CABLE GLAND
(CODE 'Lxx'/'AQxx')

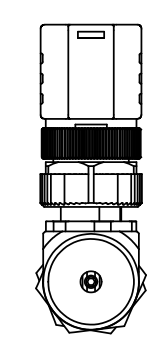
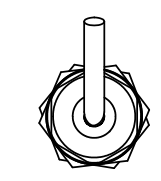

RADIAL
IP67 M12 CONNECTOR
IEC 61076-2-101
(CODE 'K')

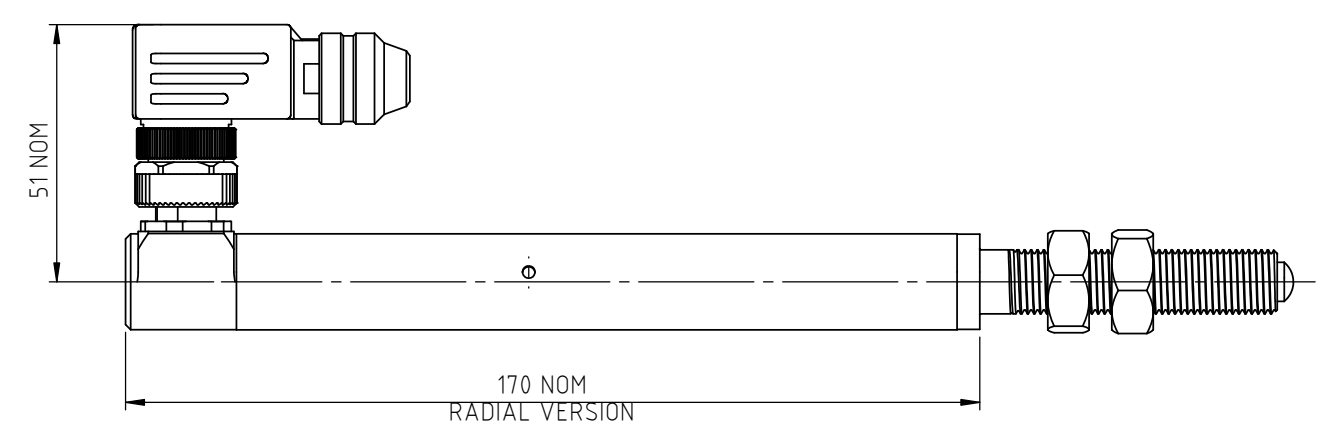

RADIAL
IP67 Pg9 CABLE GLAND
(CODE 'IAxx'/'IAQxx')

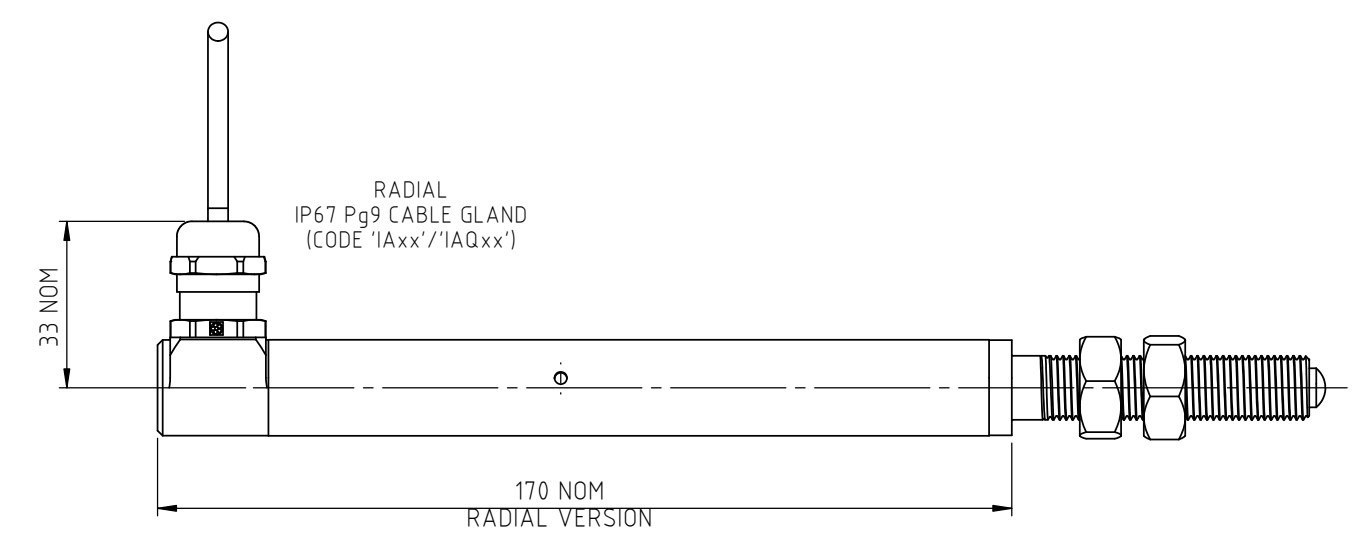

NOTE:- READ INSTALLATION SHEET M112-19 FOR FULL INSTRUCTIONS FOR USE.

ATEX / IECEx / UKEX APPROVED TO
I/II M1/1GD
Ex ia IIC T4 Ga (Ta= -40° to +80°C)
Ex ia IIIC T135°C Da (Ta= -40° to +80°C)
Ex ia I Ma (Ta= -40° to +80°C)
Ui 11.4V, Ii 0.2A, Pi 0.51W

APPROVED FOR USE IN CONJUNCTION WITH A GALVANICALLY ISOLATED BARRIER.

NOTE: APPROVAL ONLY APPLIES AT NORMAL ATMOSPHERIC PRESSURE!

DRAWINGS NOT TO BE CHANGED WITHOUT REFERENCE TO THE CHANGE PROCEDURE.
 CHANGES TO PARTS USED IN INTRINSICALLY SAFE PRODUCT MUST BE APPROVED BY THE AUTHORISED PERSON.
 THIS IS AN UNCONTROLLED PRINT AND WILL NOT BE UPDATED.

REV	CHANGE HISTORY	DR'WN	DATE	CHK'D
J	SINGLE PIECE RADIAL END CAP ADDED RAN1167	ASC	23/09/2021	ASC



APPROVED BY RDM	REV J		X ±0.4 X.X ±0.2 X.XX ±0.1 DIMs mm
DESCRIPTION M112 INTRINSICALLY SAFE GAUGE HEAD POSITION SENSOR			
SCALE 2:3	DRAWING NUMBER M112-11		
A3	SHEET 1 OF 1		



M112 GAUGE HEAD POSITION SENSOR

INTRINSICALLY SAFE FOR HAZARDOUS MINING ENVIRONMENTS

- **Intrinsically safe for Mining to: Ex I/II M1/GD**
- **Gauge head positioning for industrial and scientific applications**
- **Non-contacting inductive technology to eliminate wear**
- **Travel set to customer's requirement**
- **Compact 19 mm diameter body**
- **Sealing to IP67**

As a leading designer and manufacturer of linear, rotary, tilt and intrinsically safe position sensors, Positek® has the expertise to supply a sensor to suit a wide variety of applications.

Our M112 incorporates electronics system EX07 which is ATEX / IECEx / UKEX approved for use in potentially explosive **gas/vapour, dust** atmospheres and **mining** environments. The M112 is designed for gauge head positioning in industrial and scientific applications and is ideal for OEMs seeking good sensor performance for arduous applications in hazardous areas. The M112, like all Positek® sensors, provides a linear output proportional to travel. Each sensor is supplied with the output calibrated to the travel required by the customer, from 5mm to 50mm and with full EMC protection built in.

Overall performance, repeatability and stability are outstanding over a wide temperature range. The sensor is very robust, the body and plunger being made of stainless steel for long service life and environmental resistance.

The plunger is spring loaded with a domed end. The M112 is easy to install with a long ½ inch UNF mounting thread and is supplied with two lock nuts for positioning. Environmental sealing is to IP67.



SPECIFICATION

Dimensions

Body diameter	19 mm
Body Length (excluding thread)	
Axial version	160.7 mm
Radial version	169.5 mm
Mounting Thread Length	59 mm
Plunger extension	calibrated travel + 3.3 mm, OD 7.8 mm
<i>For full mechanical details see drawing M112-11</i>	

Spring Force

1.5 - 4.5 N approx.

Independent Linearity

± 0.25% FSO @ 20°C

Temperature Coefficients

< ± 0.01%/°C Gain &

< ± 0.01%FS/°C Offset

> 10 kHz (-3dB)

Frequency Response

Resolution

Infinite

Noise

< 0.02% FSO

Intrinsic Safety

Ex I/II M1/GD

Ex ia IIC T4 Ga (Ta= -40°C to 80°C)

Ex ia IIIC T135°C Da (Ta= -40°C to 80°C)

Ex ia I Ma (Ta=-40°C to 80°C)

Approval only applies to the specified ambient temperature range and atmospheric conditions in the range 0.80 to 1.10 Bar, oxygen ≤ 21%

Sensor Input Parameters

Ui: 11.4V, Ii: 0.20A, Pi: 0.51W.

(connector option/s)

Ci: 1.16µF, Li: 50µH

(cable option/s)

Ci: 1.36µF, Li: 860µH with 1km max. cable

Environmental Temperature Limits

Operating

-40°C to +80°C

Storage

-40°C to +125°C

Sealing

IP67

EMC Performance

EN 61000-6-2, EN 61000-6-3

Vibration

IEC 68-2-6: 10 g

Shock

IEC 68-2-29: 40 g

MTBF

350,000 hrs 40°C Gf

Drawing List

M112-11

Sensor Outline

3D models, step or .igs format, available on request.

Do you need a position sensor made to order to suit a particular installation requirement or specification? We'll be happy to modify any of our designs to suit your needs - please contact us with your requirements.



For further information please contact:

www.positek.com sales@positek.com

Tel: +44(0)1242 820027 fax: +44(0)1242 820615

Positek, Andoversford Industrial Estate, Cheltenham GL54 4LB. U.K.

M112-17r

1 of 3



M112 GAUGE HEAD POSITION SENSOR

INTRINSICALLY SAFE FOR HAZARDOUS MINING ENVIRONMENTS

Intrinsically safe equipment is defined as "equipment which is incapable of releasing sufficient electrical or thermal energy under normal or abnormal conditions to cause ignition of a specific hazardous atmosphere mixture in its most easily ignited concentration."

ATEX / IECEx / UKEX approved to;

- Ex I/II M1/GD
- Ex ia IIC T4 Ga (Ta= -40°C to 80°C)
- Ex ia IIIC T135°C Da (Ta= -40°C to 80°C)
- Ex ia I Ma (Ta=-40°C to 80°C)

Designates the sensor as belonging to; Groups I and II: suitable for all areas **(including mining)**, Category M1/1 GD: can be used in areas with continuous, long or frequent periods of exposure to hazardous gas (Zones 2 to 0) and dust (Zone 20), equipment remains energised.

Gas / Vapour:

Protection class ia, denotes intrinsically safe for all zones

Apparatus group IIC: suitable for IIA, IIB and IIC explosive gas / vapour.

Temperature class T4: maximum surface temperature under fault conditions 135°C.

Dust:

T135°C: maximum surface temperature under fault conditions.

Ambient temperature range extended to -40°C to +80°C.

It is imperative Positek® intrinsically safe sensors be used in conjunction with a galvanic barrier to meet the requirements of the product certification. The Positek X005 Galvanic Isolation Amplifier is purpose made for Positek IS sensors making it the perfect choice. Refer to the X005 datasheet for product specification and output configuration options.

For cable lengths exceeding 10 metres a five wire connection is recommended to eliminate errors introduced by cable resistance and associated temperature coefficients.

ATEX / IECEx / UKEX approved sensors suitable for gas (X series) and dust (E series) applications, are also available from Positek.

M112	a	b	c	d
	Displacement	A	Connections	Z000

a Displacement	Value
Factory set to any length from 0-5 mm to 0-50 mm (e.g. 0-36 mm).	36
b Output	Code
Supply V_{dc} (tolerance)	Output
+5V (4.5 - 5.5V)	0.5 - 4.5V (ratiometric with supply)
Supply Current 10mA typical, 12mA max.	A
c Connections	Code
Cable gland radial IP67 Pg9, metal, 3-core cable	IAxx
Cable gland radial IP67 Pg9, metal, 5-core cable	IAQxx
Connector axial IP67 4 pin M12 IEC 61076-2-101, metal	J
Connector axial IP67 4 pin M12 IEC 61076-2-101, metal, pre-wired 3-core cable	Jxx
Connector axial IP67 4 pin M12 IEC 61076-2-101, metal, pre-wired 5-core cable	JQxx
Connector radial IP67 4 pin M12 IEC 61076-2-101, metal	K
Connector radial IP67 4 pin M12 IEC 61076-2-101, metal, pre-wired 3-core cable	Kxx
Connector radial IP67 4 pin M12 IEC 61076-2-101, metal, pre-wired 5-core cable	KQxx
Cable gland axial IP67 Pg9, metal, 3-core cable	Lxx

c Connections	Code
continued	
Cable gland axial IP67 Pg9, metal, 5-core cable	LQxx
Specify required cable length 'xx' in cm. e.g. L2000 specifies axial cable gland with 20 m of cable, 50 cm supplied as standard. Note! maximum length supplied 15000cm.	
d Z-code	Code
Calibration to suit X005 required	Z000
± 0.1% FSO @20°C Independent Linearity 0 - 10 mm min.	Z650

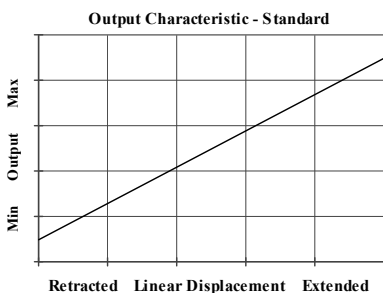

For further information please contact:

www.positek.com sales@positek.com

Tel: +44(0)1242 820027 fax: +44(0)1242 820615

Positek, Andoversford Industrial Estate, Cheltenham GL54 4LB. U.K.



Three or Five-Wire Mode Connection

FOR INTRINSICALLY SAFE SENSORS IN HAZARDOUS ATMOSPHERES

The aim of this document is to help readers who do not understand what is meant by three or five wire modes of connection between the galvanic isolation amplifier and sensor, and the factors behind them. It is by no means an in-depth technical analysis of the subject.

Whether opting for a pre-wired Positek® Intrinsicly Safe sensor or one with a connector, choosing the right mode of connection and cable to suit the application requires careful consideration.

Interconnecting cables are not perfect conductors and offer resistance to current flow, the magnitude of resistance[†] depends on conductors resistivity, which changes with temperature, cross sectional area[‡] and length. If the voltage were to be measured at both ends of a length of wire it would be found they are different, this is known as volts drop. Volts drop changes with current flow and can be calculated using Ohm's law, it should be noted that volts drop occurs in both positive and negative conductors. The effects of volts drop can be reduced by increasing the conductors cross sectional area, this does not however eliminate the effects due to temperature variation. There are instances where large cross-section cables are not practical; for example most standard industrial connectors of the type used for sensors have a maximum conductor capacity of 0.75mm², copper prices and ease of installation are other considerations.

This is important because the effects of volts drop can significantly alter the perceived accuracy of the sensor which is ratiometric i.e. the output signal is directly affected by the voltage across the sensor. Changes in temperature will also be seen as gain variation in the sensor output.

Three wire mode connections are common and are suitable in most cases with short or moderate cable runs. Applications that do not require a high degree of accuracy but have cable runs, say in excess of 10m, volts drop can be reduced by introducing a terminal box close to the sensor and using a larger cross-section cable for a majority of the cable run. Sensors supplied with three core cable are calibrated with the cable fitted which largely eliminates errors due to conductor resistance at room temperature however, as mentioned above, small gain errors due to temperature fluctuations should be expected.

Five wire mode connections have significant benefits as losses in the positive and negative conductors are compensated for by the galvanic isolation amplifier which can 'sense' the voltage across the sensor and dynamically adjust the output voltage so that the voltage across the sensor is correct. The effects of cable resistance and associated temperature coefficients are eliminated allowing for smaller conductors than a three wire connection for the same cable run. The amplifier can compensate for up to 15Ω per conductor with a current flow of 15mA, which is more than adequate for 150m of 0.25 mm² cable, longer lengths will require larger conductors.

For this reason Positek® recommends five wire connections for cable lengths exceeding 10 metres in 0.25 mm² cable to preserve the full accuracy of the sensor.

See illustrations below for examples of connecting a sensor to the galvanic isolation amplifier.

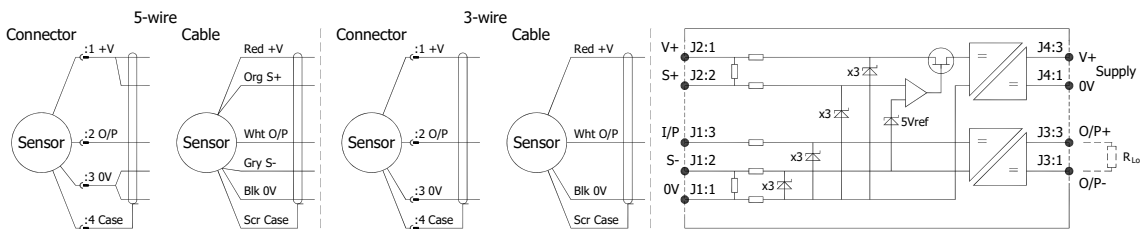

Cable Length (metres)	Up to 150	150 - 300	300 - 450	450 - 600	600 - 900	900 - 1000
Cross Section (mm ²)	0.25	0.5	0.75	1.0	1.5	2.0

The table above shows recommended conductor sizes with respect to cable length for both three and five wire connections, based on copper conductors. Three wire connections will introduce a gain reduction of 5% and a ±1% temperature dependence of gain over the range -40°C to +80°C for the cable temperature. (i.e. about -150 ppm/°C for the maximum lengths shown and less pro rata for shorter lengths.)

It should be noted that the maximum cable length, as specified in the sensor certification, takes **precedence** and **must not** be exceeded.

Positek® sensors are supplied with three core 0.25 mm² cable as standard, however five core 0.25 mm² cable can be supplied on request. The galvanic isolation amplifier is available as;

G005-*** for 'G' and 'H' prefix sensors
X005-*** for 'E', 'M' and 'X' prefix sensors

[†] $R = \rho L/A$ ρ is the resistivity of the conductor (Ωm) L is the length of conductor (m) A is the conductor cross-sectional area (m²).

[‡] It is presumed that direct current flow is uniform across the cross-section of the wire, the galvanic isolation amplifier and sensor are a dc system.



For further information please contact:

www.positek.com sales@positek.com

Tel: +44(0)1242 820027 fax: +44(0)1242 820615

Positek, Andoversford Industrial Estate, Cheltenham GL54 4LB. U.K.



Installation Information

M112 GAUGE HEAD POSITION SENSOR

INTRINSICALLY SAFE FOR HAZARDOUS MINING ENVIRONMENTS

For certificate number and safety parameters information for product marked EX04, see next page.

ATEX / IECEx / UKEX Qualified to Intrinsic Safety Standard Certificate numbers SIRA 13ATEX2371X IECEX SIR 13.0154X CSAE 21UKEX2537X		Ex I/II M1/1GD Ex ia IIC T4 Ga (Ta = -40°C to +80°C) Ex ia IIIC T135°C Da (Ta = -40°C to +80°C) Ex ia I Ma (Ta = -40 to +80°C)	
Electronics Version	Output Description:	Supply Voltage: V _s (tolerance)	Load resistance:
EX07	0.5 - 4.5V (ratiometric with supply) [Output code 'A']	+5V (4.5 - 5.5V)	5kΩ min

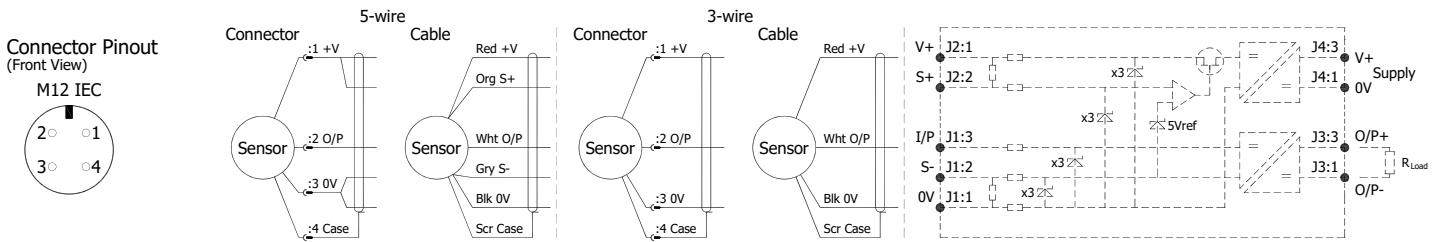

Putting Into Service: The sensor must be used with a galvanic isolation barrier designed to supply the sensor with a nominal 5V and to transmit the sensor output to a safe area. The barrier parameters must not exceed:-

U_i = 11.4V **I_i = 0.20A** **P_i = 0.51W**
C_i = 1.36μF* **Li = 860μH*** (with maximum cable length)
C_i = 1.16μF **Li = 50μH** (without cable)

*Figures for 1km cable where: C_i = 200pF/m & L_i = 810nH/m

The sensor is certified to be used with up to **1000m** of cable, cable characteristics must not exceed:-

Capacitance: ≤ 200 pF/m or max. total of: 200 nF
 Inductance: ≤ 810 nH/m or max. total of: 810 μH

Approval only applies to specified ambient temperature range and atmospheric conditions in the range: 0.80 to 1.10 Bar, oxygen ≤ 21%.

The performance of the sensor may be affected by voltage drops associated with long cable lengths; For cable lengths exceeding 10 metres a five wire connection is recommended to eliminate errors introduced by cable resistance and associated temperature coefficients.

Warning - The M12 IEC connector may be rotated for purposes of convenient orientation of the connector and cable, however rotating the connector more than one complete revolution is not recommended. **Repeated rotation of the connector will damage the internal wiring!**

Special Condition for Safe Use:

The apparatus does not meet the 500 V r.m.s dielectric strength test between circuit and frame, in accordance with clause 6.3.13 of IEC 60079-11:2011. This must be taken into consideration on installation.

When using a Sensor that has an integral cable in a dust application, the free end of the cable shall be appropriately terminated for the zone of use. Under certain extreme circumstances, the non-metallic and isolated metal parts incorporated in the enclosure of this equipment may generate an ignition-capable level of electrostatic charge. Therefore the equipment shall not be installed in a location where the external conditions are conducive to the build-up of electrostatic charge on such surfaces. This is particularly important if the equipment is installed in a zone 0 location. In addition, the equipment shall only be cleaned with a damp cloth.

Use: The sensor is designed to measure linear displacement and provide an analogue output signal.

Assembly and Dismantling: The unit is not to be serviced or dismantled and re-assembled by the user.

Maintenance: No maintenance is required.

Mechanical Mounting: Via ½"x20 UNF mounting thread, adjust sensor position and lock in place using lock nuts provided. Maximum tightening torque: 10Nm.

Output Characteristic: Plunger is extended 3.3 mm from end of body at start of normal travel. The output increases as the plunger extends from the sensor body, the calibrated stroke is between 5 mm and 50 mm.

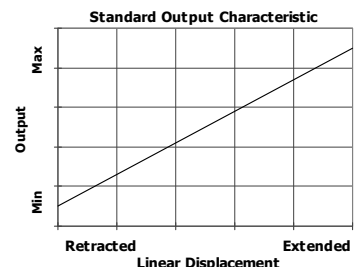

Incorrect Connection Protection levels: Not protected – the sensor is **not** protected against either reverse polarity or over-voltage. The risk of damage should be minimal where the supply current is limited to less than 50mA.



For further information please contact:
www.positek.com sales@positek.com
 Tel: +44(0)1242 820027 fax: +44(0)1242 820615
 Positek, Andoversford Industrial Estate, Cheltenham GL54 4LB. U.K.



Installation Information

M112 GAUGE HEAD POSITION SENSOR

INTRINSICALLY SAFE FOR HAZARDOUS MINING ENVIRONMENTS

For certificate number and safety parameters information for product marked EX07, see previous page.

ATEX Qualified to Intrinsic Safety Standard Certificate numbers SIRA 00ATEX2076X		Ex I/II M1/1GD EEx ia I/IIC T4 (Ta = -40°C to +80°C) Ex ia D 20 T135°C (Ta = -40°C to +80°C)	
Electronics Version	Output Description:	Supply Voltage: V _s (tolerance)	Load resistance:
EX04	0.5 - 4.5V (ratiometric with supply) [Output code 'A']	+5V (4.5 - 5.5V)	5kΩ min

The barrier parameters must not exceed:-

U_i = 11.4V **I_i = 0.20A** **P_i = 0.51W**
C_i = 1.36μF* **L_i = 710μH*** ('Lxx' option) *Figures for 1km cable
C_i = 1.16μF **L_i = 50μH** ('J' or 'K' options)

The sensor is certified to be used with up to **1000m** of cable, cable characteristics must not exceed:-

Capacitance: ≤ 200 pF/m for max. total of: 200 nF
Inductance: ≤ 660 nH/m for max. total of: 660 μH

With the exception of the certificate number and safety parameters above, all other notes regarding Putting Into Service, Use, Assembly and Dismantling etc. on previous page apply to sensors marked EX04 or EX07.



For further information please contact:

www.positek.com sales@positek.com

Tel: +44(0)1242 820027 fax: +44(0)1242 820615

Positek, Andoversford Industrial Estate, Cheltenham GL54 4LB. U.K.